

RAPID

A Portable and Reconfigurable Imaging Interferometer Array

Colin Lonsdale, Frank Lind

and a team of ~10

MIT Haystack Observatory

Cambridge University Team

Led by Andy Faulkner

JPL Team

Led by Chris Mattman



RAPID

UNIVERSITY OF
CAMBRIDGE

JPL



Radio Array of Portable Interferometric Detectors

- **Low frequency radio array, 48-615 MHz**
- **~50-75 solar-powered, portable antennas**
- **No copper or fiber connections**
- **Local storage of voltage samples at each antenna**
- **Imaging interferometry performed offline**
- **Low-cost setup and breakdown**
- **Highly portable and reconfigurable**



RAPID capabilities

A whole new level of flexibility ...

- Ship array to best site for the science goals
 - Zero site infrastructure required
- Set up complete array in a day or two
 - Goal - 20 person minutes per element
- Reconfigure the array in a few hours
- Collect data as needed
 - over hours, days or weeks
 - in multiple configurations if required
- Pack up in a day or two and ship out
- Process offline with complete flexibility

The RAPID System

RAPID Field Unit

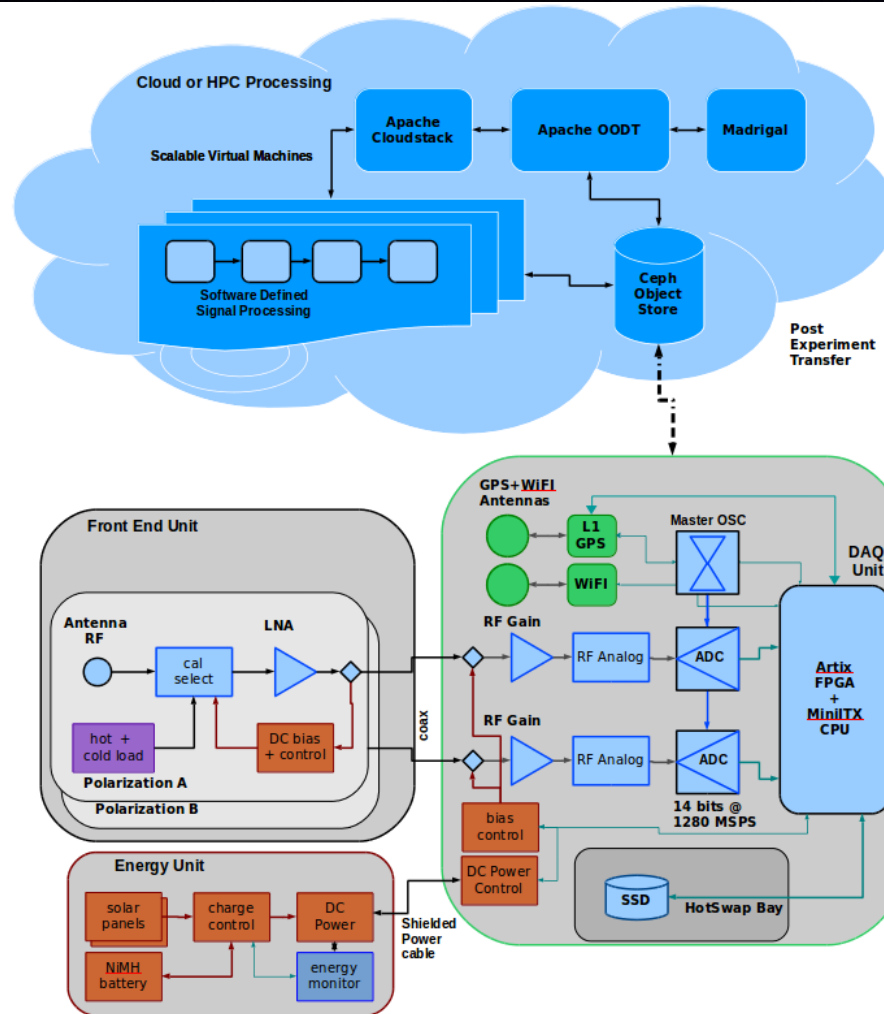
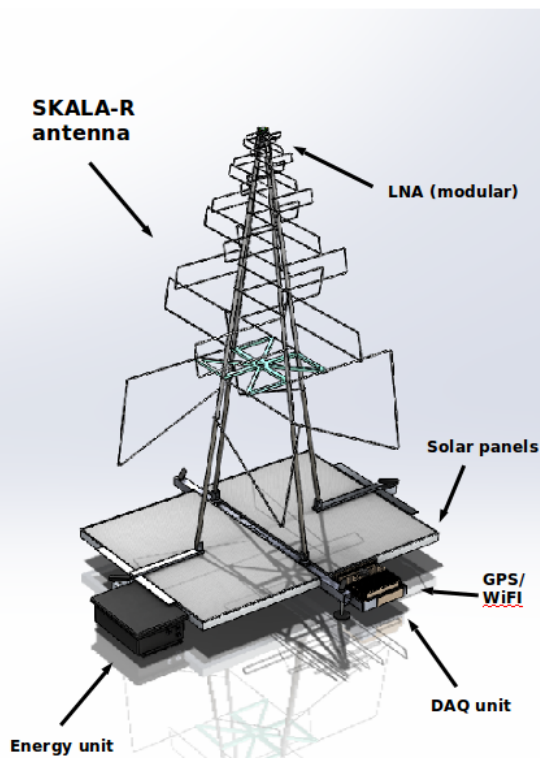

SKALA-R



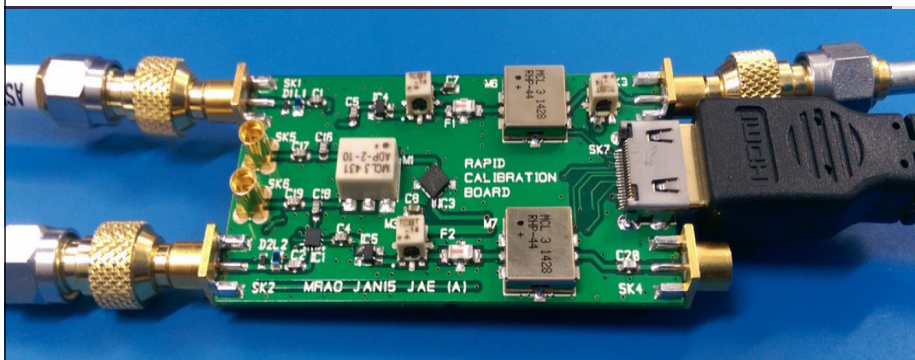
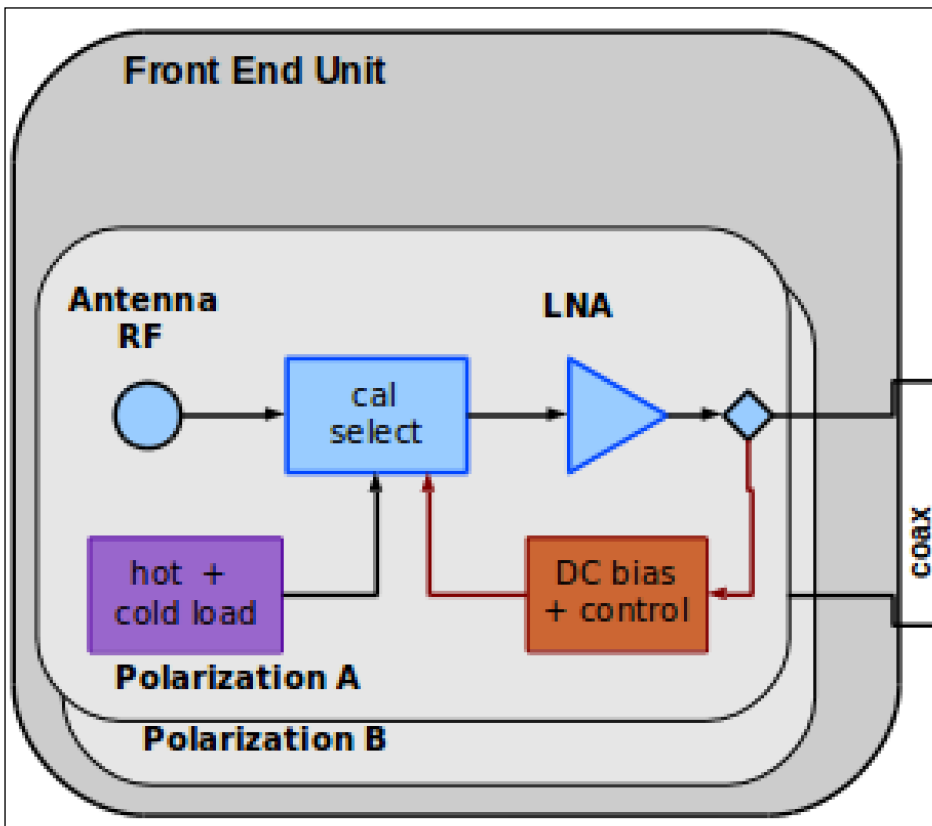

● Modular LNA

- Precision calib. version
- Low noise version (SKA)

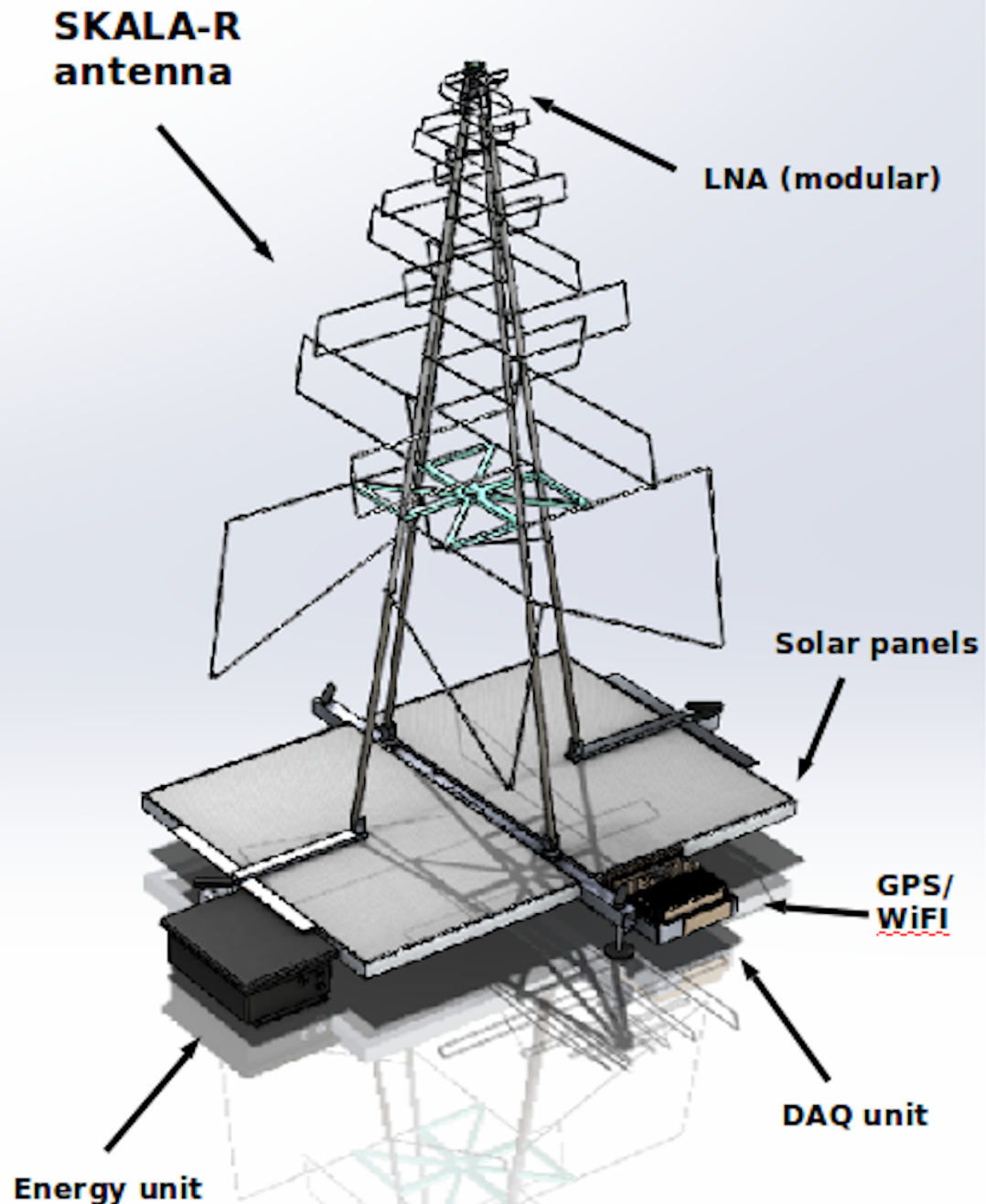

Energy Unit

- Can use Li Ion or NiMH
- Choice depends on

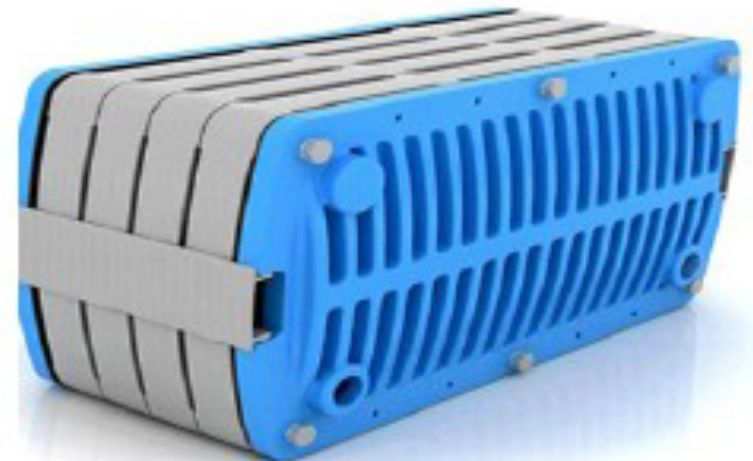
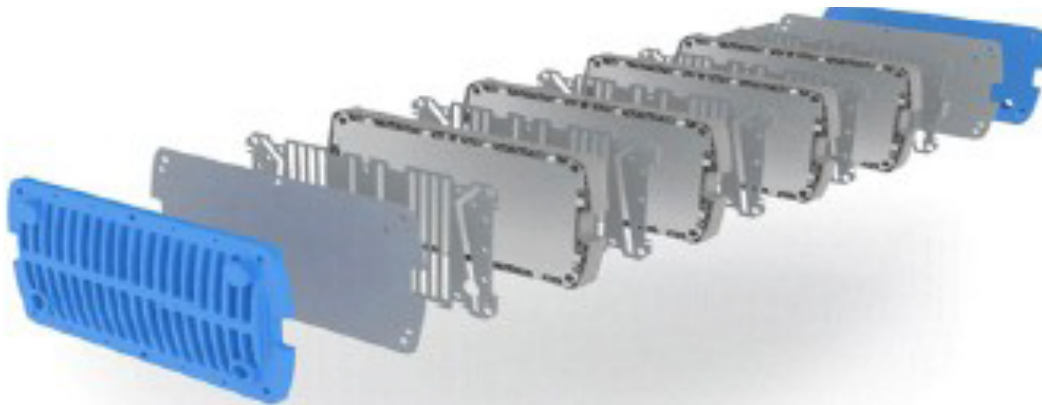
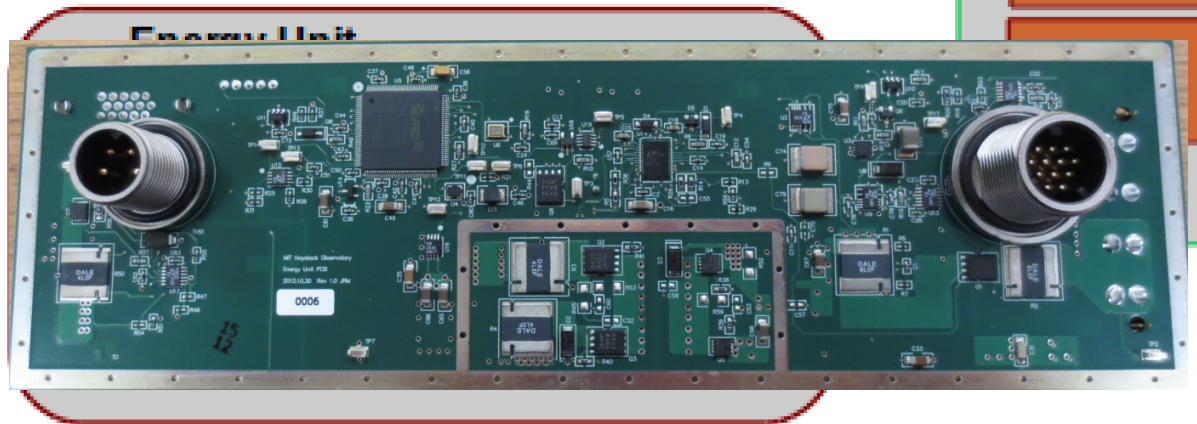

DAQ Unit

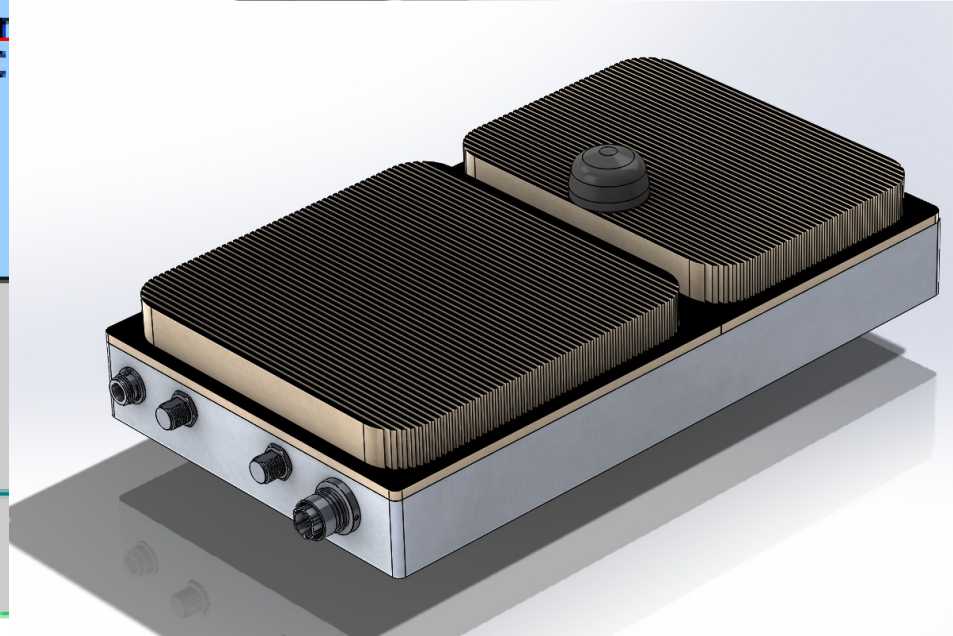
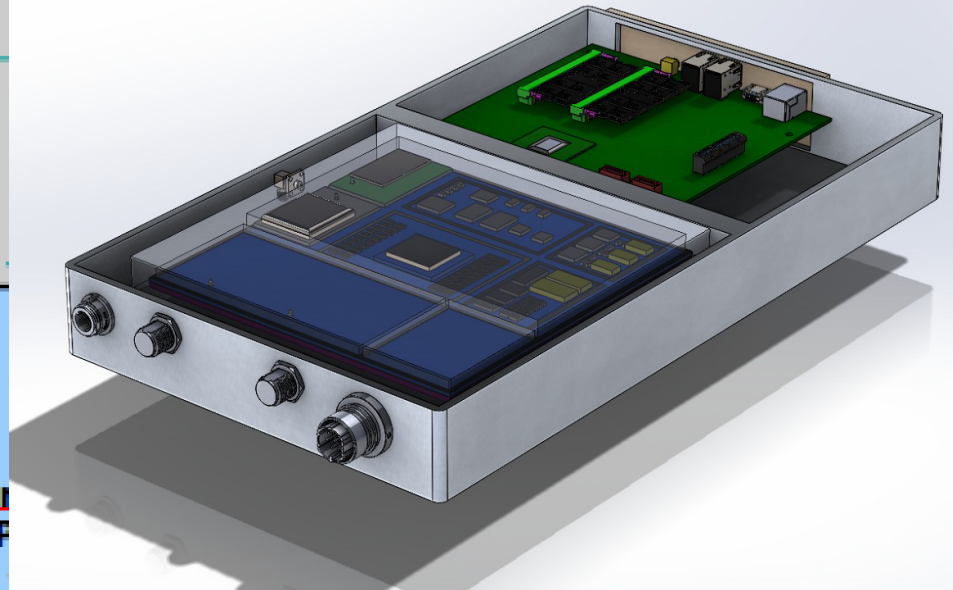
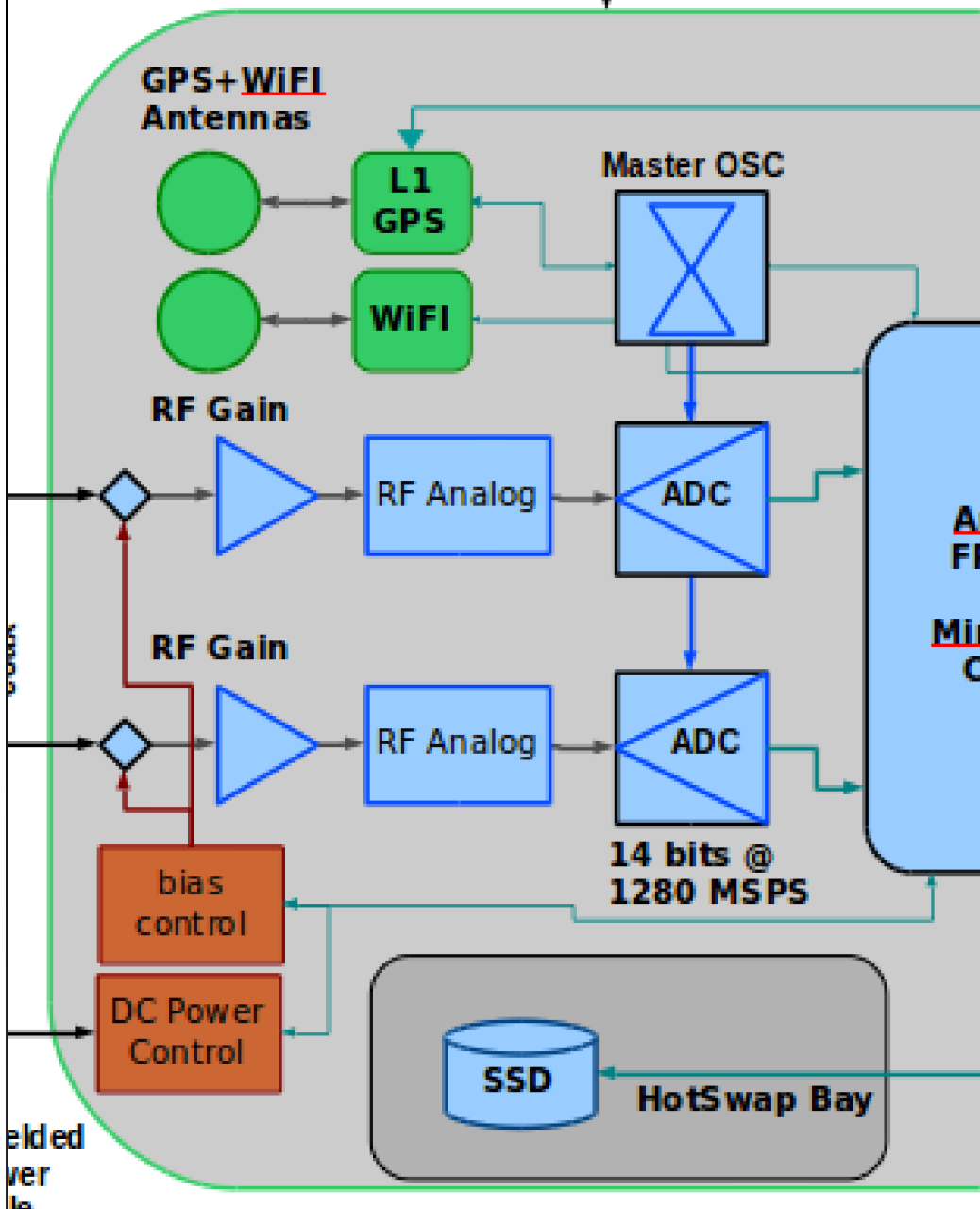

Mobile support infrastructure

- **Array layout measurement**
- **Intra-array communication**
- **Quick look data capture, functional checks, event response, ...**
- **Environmental data**
- **Backup phasing beacon**

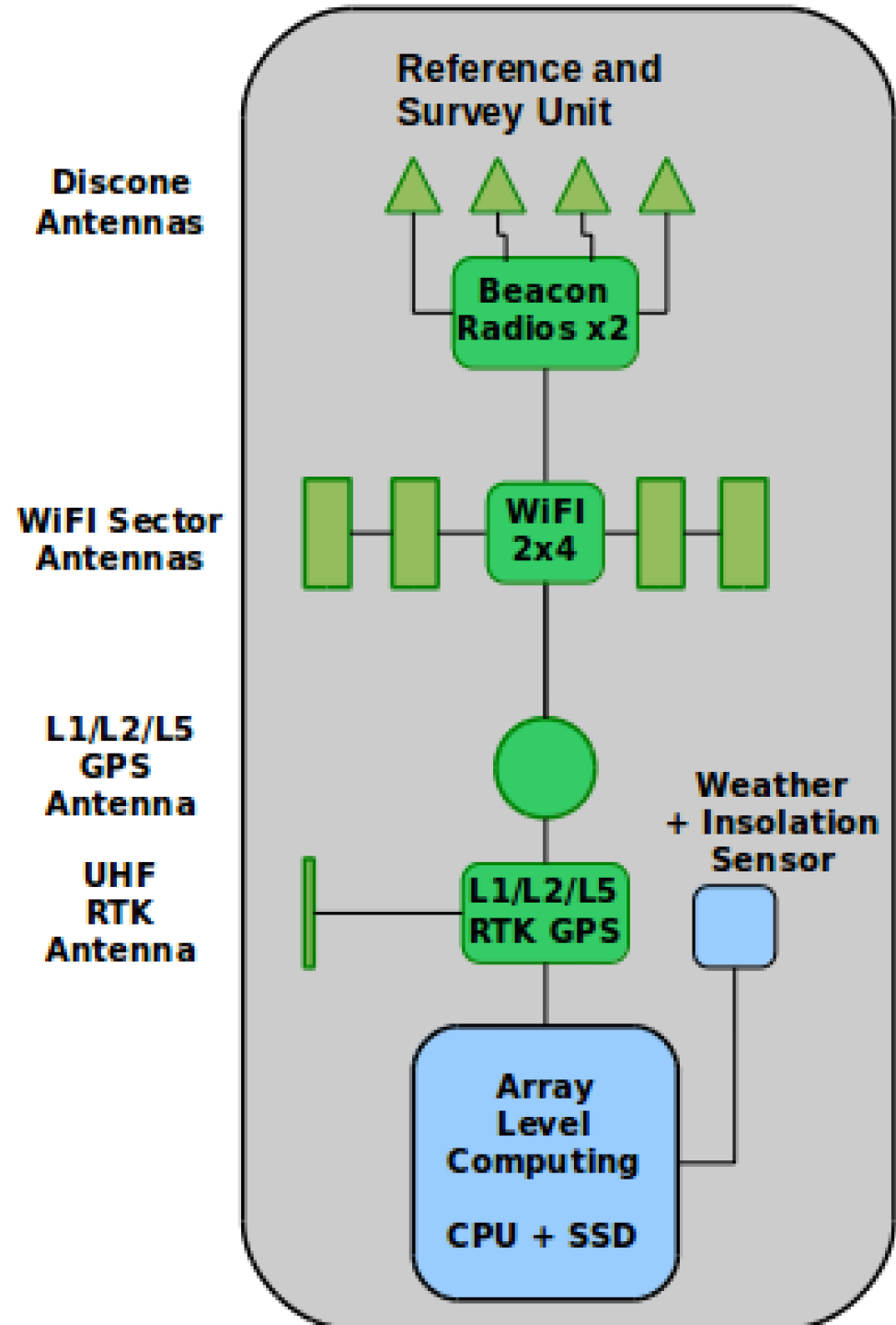

Offline Data Processing

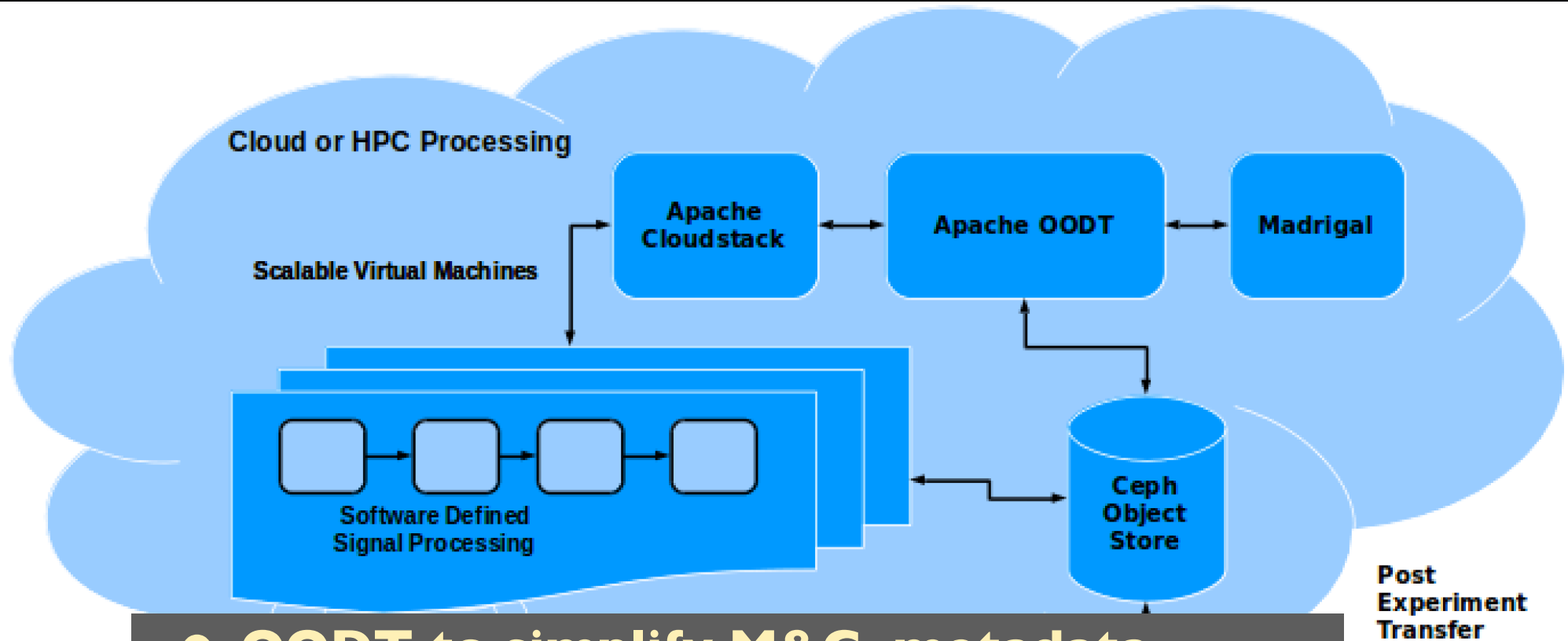

- **OODT to simplify M&C, metadata handling**
- **Modular, highly scalable processing**
 - Correlation, and various other signal processing tasks
 - Developed with evolving processor architectures in mind

Interferometry Demonstration

RAPID DXP-1 (SKALA-1, SKALA-2, 190 meters, AA) 2015-08-30 20:58:38UT (440.2 MHz ; UHF Radar Active)

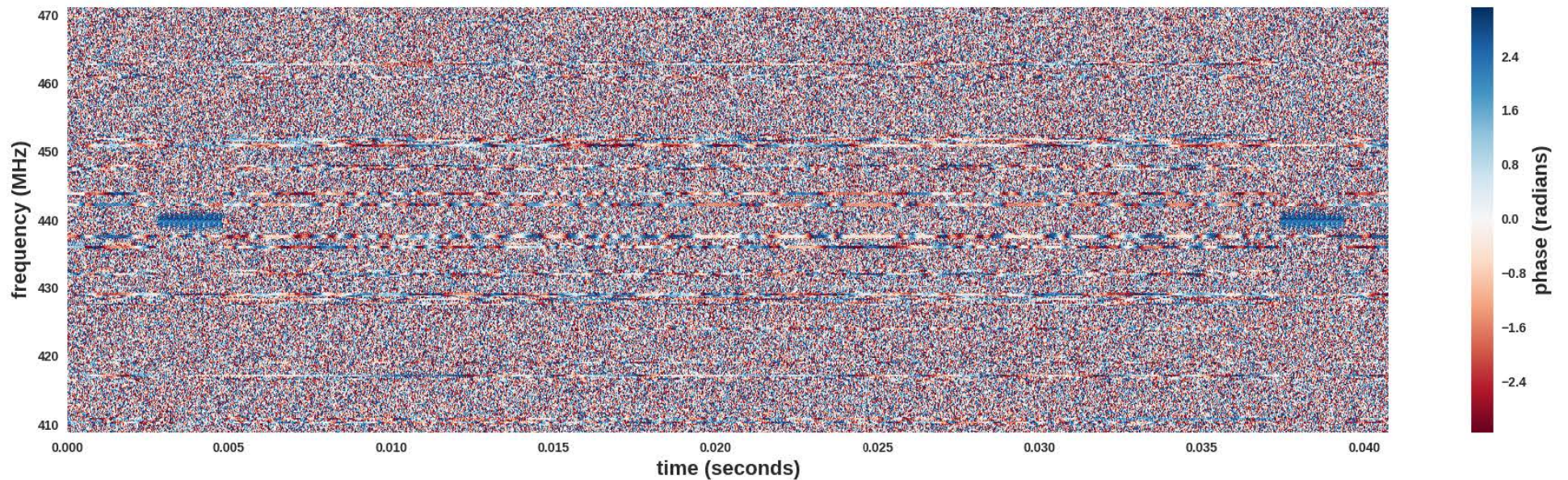
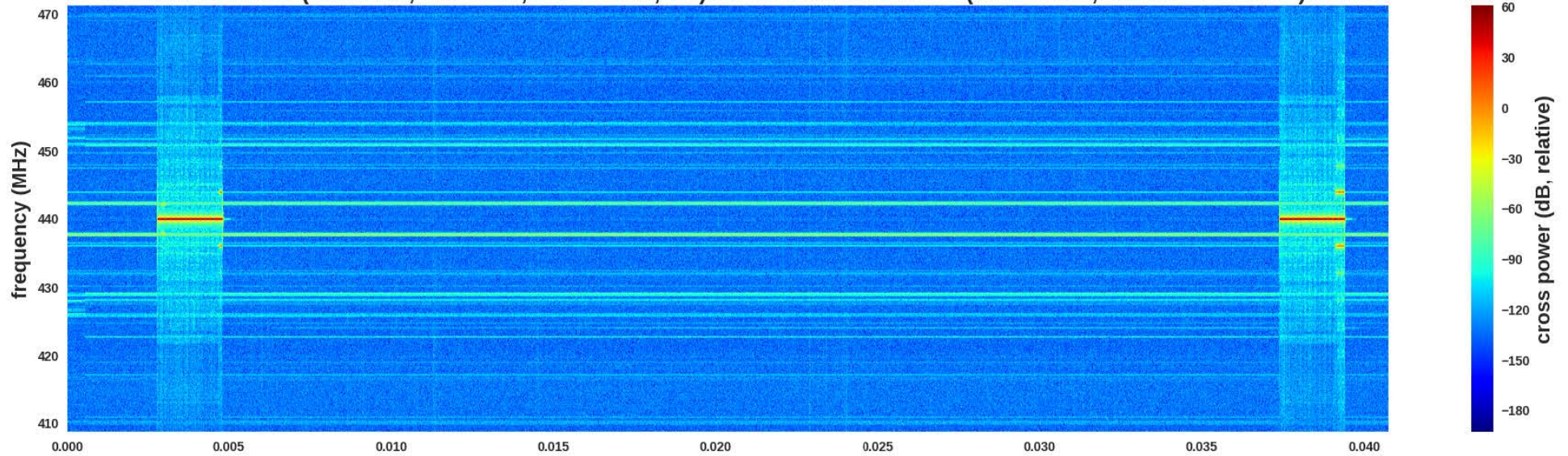

Current Status

- **Sustained 8 Gbit/sec, antenna to SSD**
 - Peak power draw ~30W, production unit ~20W
 - Meets or significantly exceeds all requirements
 - Primary project risk retired
- **Several major components complete**
 - SKALA-R antenna system
 - Energy unit
 - All essential software and firmware
- **DAQ unit integration in progress**
 - Production prototype early 2016
- **Production run, commissioning in 2016**

Galactic synchrotron imaging

Single dish narrowband total power data
~1 degree resolution
Significant artifacts at low levels
30 years old, still the gold standard

RAPID goals:
Higher resolution, higher fidelity
Broadband coverage from 48-615 MHz
Scalable, custom configuration is key

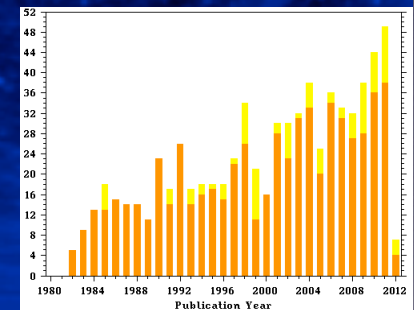

408 MHz sky, Haslam et al., 1981

Citations per year

Advanced Radio Apertures

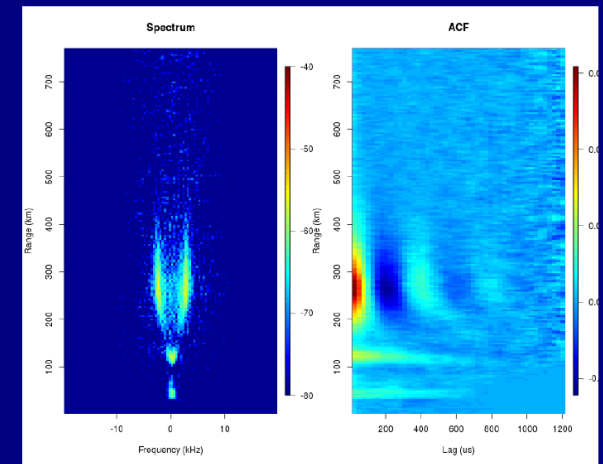

[McKay-Bukowski, et al., 2014]



The Astronomy Community
has invested heavily in
Low Frequency Radio Array
Technology Development

Enabled by software radio

Just Add a Transmitter...

Rich Geospace Science

“Photosphere to Mud”

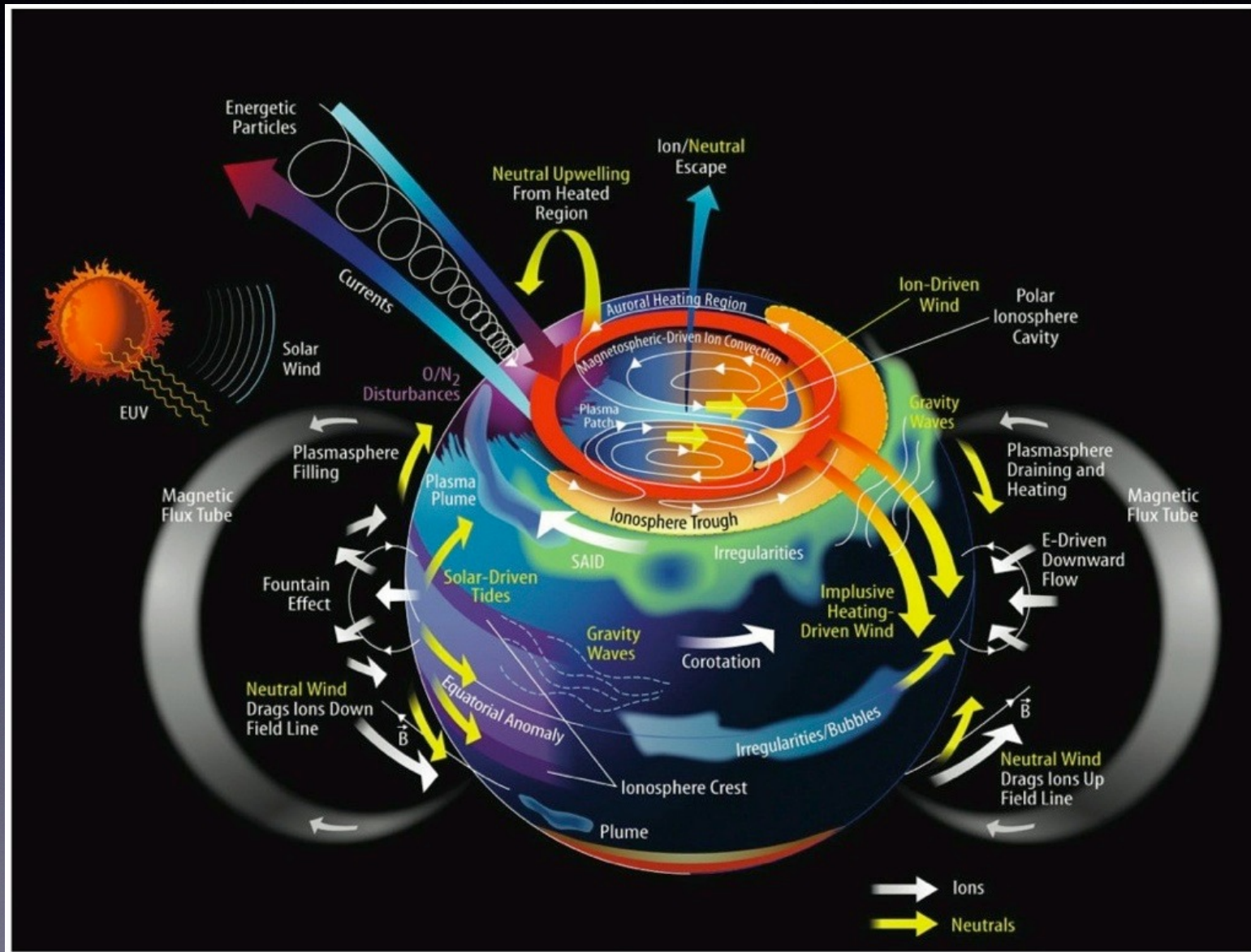

RAPID configuration for solar imaging

- **Need:**

- Excellent monochromatic instantaneous coverage
- No very short baselines
- High angular resolution

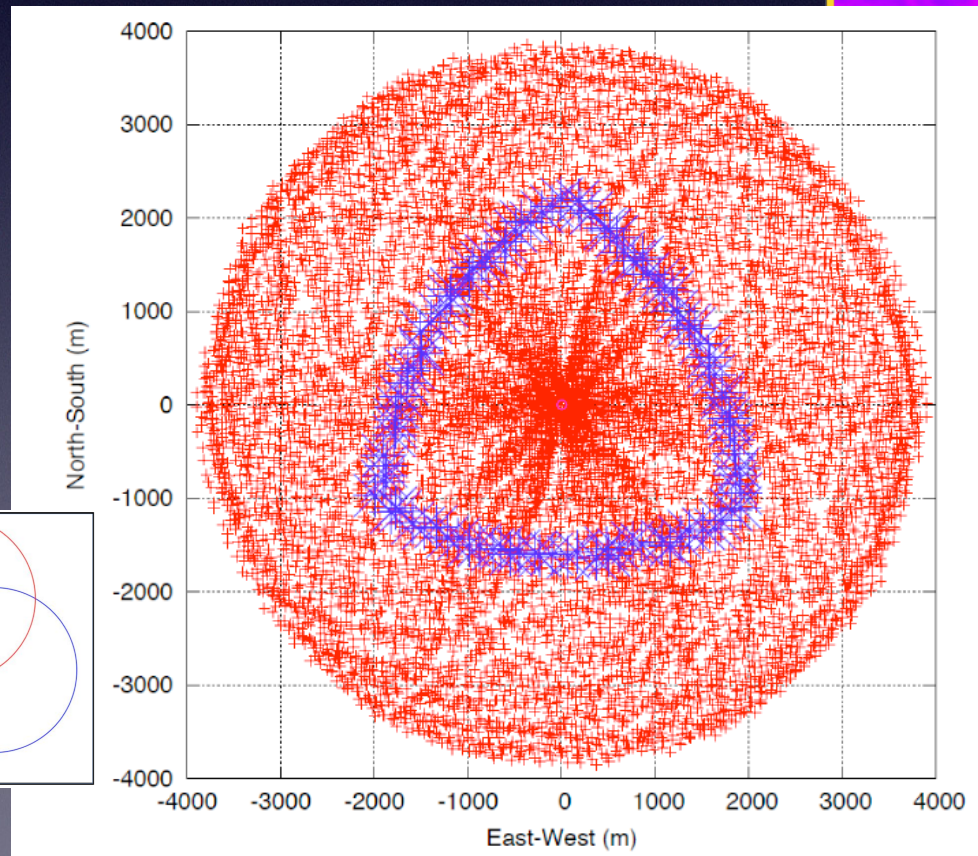
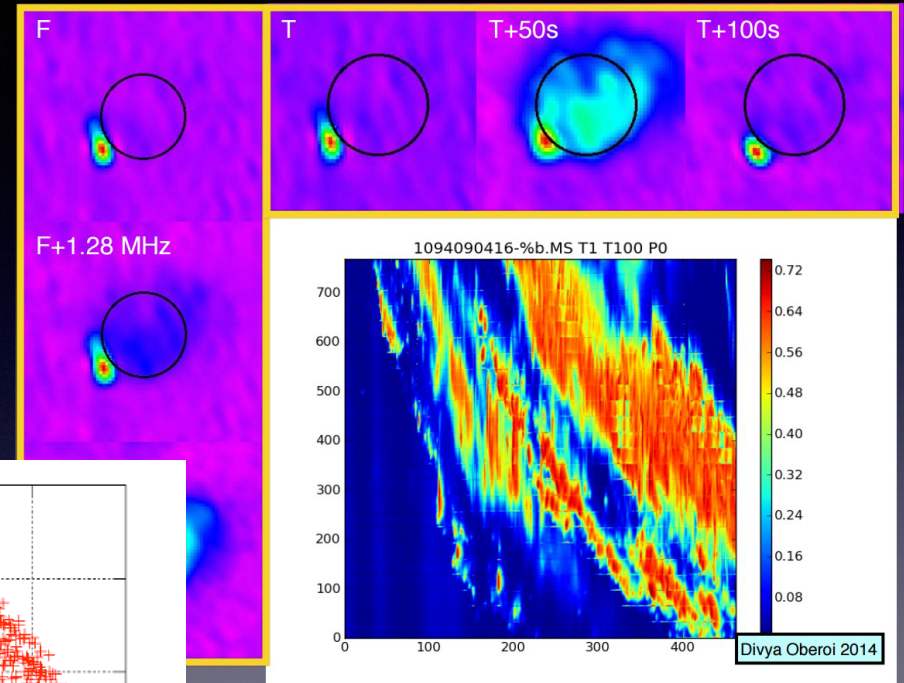

extraordinary uv
plane sampling,
high DR imaging
at optimum
resolution

RAPID deployments for Radar

- Jicamarca, Peru
 - 49 MHz high power transmitter
 - Rich equatorial ionospheric phenomenology
- Poker Flat, Alaska
 - AMISR illuminator
 - Rich auroral phenomenology
 - Simultaneous Mahali GPS campaign
 - Data fusion

RAPID deployment for UHECR

- Ship to location of particle detector array
 - Use particle detectors to trigger radio capture
 - Avoid false positive problem (RFI)
 - Cyclic memory buffer, relaxed response time to events
- Tailor configuration to goals, e.g.
 - For energetic, rare events, cover large area
 - For detailed study of weaker, frequent events, sample the “footprint” densely
 - and anything in between

“Future” Aspects

- **Direct RF digitization, no analog mixing**

- Increasingly prevalent in radio astronomy
- ADC technology advancing rapidly

- **Voltage recording, offline processing**

- Minimal compromises at observe time
- Anticipates affordability of massive memory
- Minimizes custom engineering for real time data handling
- Development of a software processing ecosystem
- Delayed information destruction - process as/how needed

- **Autonomous units, reduced infrastructure dependence**

- Very low power systems; cheap accurate frequency standards
- Greater freedom in placement, configuration

“Deep memory” is coming

Store *and keep* all voltages

3D XPoint™ Technology: An Innovative, High-Density Design

Cross Point Structure

Perpendicular wires connect submicroscopic columns. An individual memory cell can be addressed by selecting its top and bottom wire.

Stackable

These thin layers of memory can be stacked to further boost density.

Basic physical mechanism
scalable to 4 nm feature sizes

Non-Volatile

3D XPoint™ Technology is non-volatile—which means your data doesn't go away when your power goes away—making it a great choice for storage.

Selector

Whereas DRAM requires a transistor at each memory cell—making it big and expensive—the amount of voltage sent to each 3D XPoint™ Technology selector enables its memory cell to be written to or read without requiring a transistor.

High Endurance

Unlike other storage memory technologies, 3D XPoint™ Technology is not significantly impacted by the number of write cycles it can endure, making it more durable.

Memory Cell

Each memory cell can store a single bit of data.

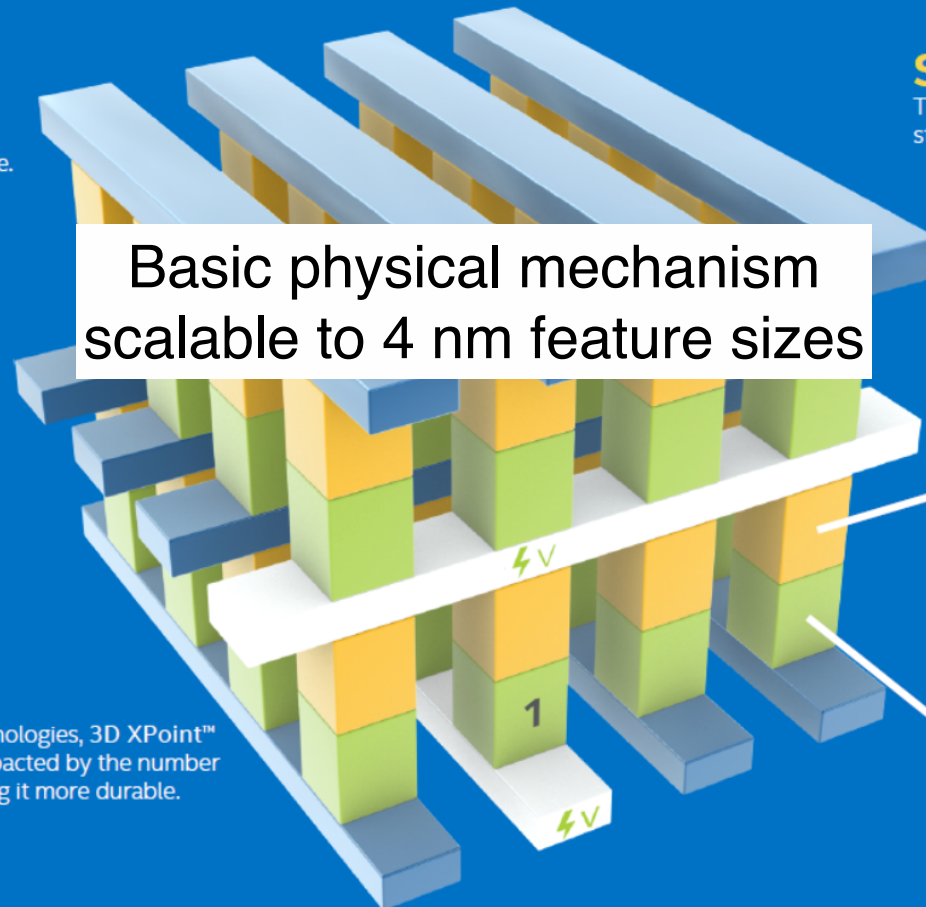

Handling Data Volumes

- **Modular, scalable software infrastructure**

- Exploit new machine architectures quickly/efficiently
- Minimize lag relative to Moore's law industry progress

- **Data ⇒ Information ⇒ Patterns ⇒**

- Understanding**

- Distillation process, ending in scientific understanding
- Early stages are quickly growing beyond human cognitive capacity
- Machine role in discovery process must migrate to the right ...

- **RAPID is a testbed**

- Up to ~0.5 Tbit/sec, petabyte-level acquisition per campaign
- Strong signal targets, high information per bit

Summary

- **RAPID version 1 is nearing completion**

- Uniquely flexible in location and configuration
- Highly modular for different applications
- Designed with diverse future variants in mind

- **Emphasis on anticipating technological trends**

- Seek architecture that spans technology cycles
- Exploit new, better devices with minimum development
- Software whenever possible, not hardware or firmware

- **Future plans**

- Scientific use of the array - collaborations enthusiastically welcomed
- Experiments in conjunction with LWA, LOFAR, MWA
- Translation of technologies to radars, space-based arrays, ...
- RAPID 256, RAPID 1000, RAPID versions 2, 3, ...